

lotus 1-063

Werkentwurf, 1960

Sitz gepolstert, Rücken, Hinterfüsse und Sitzzarge massiv gebogen

B44, T52, H81, SH47

Werkentwurf, 1960

Siège rembourré, pieds arrière, dossier et cadre du siège en bois massif cintré

L44, P52, H81, HAss47

Werkentwurf, 1960

Upholstered seat, back, rear legs and seat frame of solid bentwood

W44, D52, H81, SH47

Varianten / variantes / variants



lotus
1-060

Technische Angaben / specifications / specifications

Masse / mesure / measure

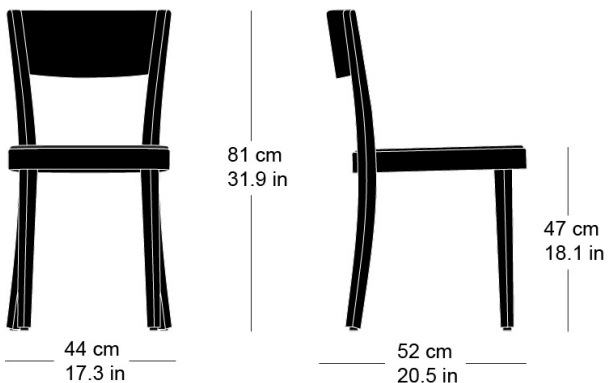

Gewicht / poids / weight 4.9 kg 9.8 lb

Polsterung / rembourrage / upholstery ja / oui / yes

lotus 1-063

Holzarten / types de bois / types of wood



Buche natur HG 520
Natural beech HG 520
Hêtre naturel HG 520



Buche anthrazit HG 200
Anthracite beech HG 200
Hêtre anthracite HG 200



Buche weiss HG 330
White beech HG 330
Hêtre blanc HG 330



Buche Ebony HG 100
Ebony beech HG 100
Hêtre teinté ebony HG 100



Buche hellgrau HG 340
Light grey beech HG 340
Hêtre clair gris HG 340



Buche Wenge HG 110
Wenge beech HG 110
Hêtre teinté wenge HG 110



Buche grau HG 350
Grey beech HG 350
Hêtre gris HG 350

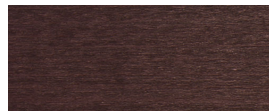

Buche Mahagoni HG 130
Mahogany beech HG 130
Hêtre teinté mahagoni HG 130



Buche schwarz HG 203
Black beech HG 203
Hêtre noir HG 203



Buche Maron HG 120
Maron beech HG 120
Hêtre teinté maron HG 120



Buche Nuss HG 151
Nut beech HG 151
Hêtre teinté noyer HG 151



Buche geweisst HG 172
Whitewashed beech HG 172
Hêtre teinté blanc HG 172

Belag / revêtement / surface