

miro barhocker 11-580

Hannes Wettstein, 2004

Sitz Formsperrholz, Holzgestell massiv

B34, T34, SH80

Hannes Wettstein, 2004

Assise en contreplaqué moulé, piètement en bois massif

L34, P34, HAss80.

Hannes Wettstein, 2004

Moulded plywood seat, solid wooden frame

W34, D34, SH80

Varianten / variantes / variants

Miro
11-560Miro
6-400Miro
6-400aMiro
6-403Miro
6-403aMiro
11-300Miro
11-400Miro
11-403Miro
11-303

Technische Angaben / specifications / specifications

Masse / mesure / measure

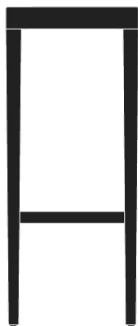
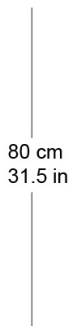
34 cm
13.4 in80 cm
31.5 in34 cm
13.4 in

Gewicht / ponds / weight

4.2 kg 8.4 lb

miro barhocker 11-580

Holzarten / types de bois / types of wood

Belag / revêtement / surface



Buche natur BN 000 AM
Beech natural BN 000 AM
Hêtre naturel BN 000 AM



Buche schwarz BB 203 SG
Beech black BB 203 SG
Hêtre noir BB 203 SG



Eiche natur EN 000 AM
Oak natural EN 000 AM
Chêne naturel EN 000 AM



Buche anthrazit BB 200 SG
Beech anthracite BB 200 SG
Hêtre anthracite BB 200 SG



Esche natur FN 000 AM
Ash natural FN 000 AM
Frêne naturel FN 000 AM



Eiche Räuchereiche EB 535 AM
Oak smoked oak EB 535 AM
Chêne chêne fumée EB 535 AM



Buche geweisst BG 172 SG
Beech whitewashed BG 172 SG
Hêtre teinté blanc BG 172 SG



Buche Ebony BB 100 SG
Beech ebony BB 100 SG
Hêtre teinté ebony BB 100 SG



Esche weisspigmentiert FW 001 OL
Ash white-pigmented FW 001 OL
Frêne pigmenté blanc FW 001 OL



Buche Nuss BB 151 SG
Beech walnut BB 151 SG
Hêtre teinté noyer BB 151 SG



Esche schwarz FB 203 AM
Ash black FB 203 AM
Frêne noir FB 203 AM